



**VALVE GUIDE
FOR THE PULP &
PAPER INDUSTRY**



The DeZURIK Difference

Throughout our 250 years of combined history, DeZURIK, APCO, and HILTON have been recognized worldwide for collaborating with customers to design and engineer valves that provide superior performance and value. Each company was founded by an innovator who set out to solve a customer's problem application.

DeZURIK's founder, Matt DeZURIK, started designing products for the Sartell Paper Mill in 1925 that included knot boring machines, consistency transmitters and shower pipes. When he noticed that valves weren't able to seal due to pitch build-up, he invented the first Eccentric Plug Valve – a design still in use today, dutifully solving sealing problems worldwide.

Today, the DeZURIK, APCO, and HILTON brands continue the tradition of partnering with our customers in the Pulp & Paper industry to provide the newest innovations in control, gate, plug, butterfly, automatic air and check valves. Our vision is to deliver exceptional value to our customers by applying our valve and problem-solving expertise to improve their operational performance.



DeZURIK's original Eccentric Plug Valve, developed in 1925 for the Sartell Paper Mill to solve a problem with pitch build-up.



DeZURIK Knife Gate Valves and V-Port Ball Valves are widely used in pulping and stock prep operations throughout the mill.

Full-Featured Valves for Today Applications

DeZURIK recognizes the importance that control valves can play in process control performance and productivity. That's why DeZURIK is dedicated to control valve testing. Regulating critical aspects of control valve performance such as accuracy, hysteresis, deadband and response time ensures that DeZURIK control valves provide optimum performance and help reduce costs.



Ruggedly Designed for Maximum Value

DeZURIK engineers spend many hours in the field listening to customers so they fully understand the intricacies of each application and incorporate that knowledge into each valve design. Using the latest advancements in technology such as Solid Modeling, Finite Element Analysis, 3D Rapid Prototyping and Computational Fluid Dynamics, DeZURIK engineers create valves that offer superior installed performance.

Quality Centered Manufacturing

DeZURIK's dedication to quality is demonstrated in all aspects of the business but foremost in our manufacturing capabilities. Our state-of-the-art CNC machining centers and large valve fabrication facilities allow us to produce in excess of 100,000 valves annually that range in size from 1/2" to 144" and weigh up to 40 tons. DeZURIK's dedication to outstanding practices is ingrained in its culture, and exemplified in our quality system. DeZURIK has been certified to the ISO 9001 standard since 1996.



DeZURIK High Performance Butterfly Valves are ideally suited for a wide variety of services including water, steam, liquor and other corrosive liquids and gases.



DeZURIK PEC Eccentric Plug Valve in pulp mill green liquor isolation

2-Year Manufacturer's Warranty

To further demonstrate our confidence in our product quality, DeZURIK offers a 2-Year Manufacturer's Warranty as standard - double the length of time offered by most other manufacturers.

Wide Selection of Valve Styles

DeZURIK has a wide variety of valve styles to meet the application requirements of the pulp and paper industry. DeZURIK manufactures valves for basis weight control, paper stock, liquor, steam, dilution water control and others. Valve styles that can handle everything from abrasive Kaolin clay slurries to recycle trash. The application guide charts on the following pages serve as a starting point in the valve selection process. For additional information or to contact your local representative, visit us at DeZURIK.com.

Application Expertise You Can Trust

The application expertise of DeZURIK technical sales representatives, located throughout the world, will ensure you receive the personalized and complete service you need to keep your process performing at optimum levels. Our independent representatives are backed by over 500 DeZURIK employees at our factories, service centers and offices whose primary goal is customer satisfaction and maintaining long-term relationships.



DeZURIK's Precision Electric Basis Weight Control Valve is specifically designed for critical paper stock control, and is used for basis weight and head box level control applications.

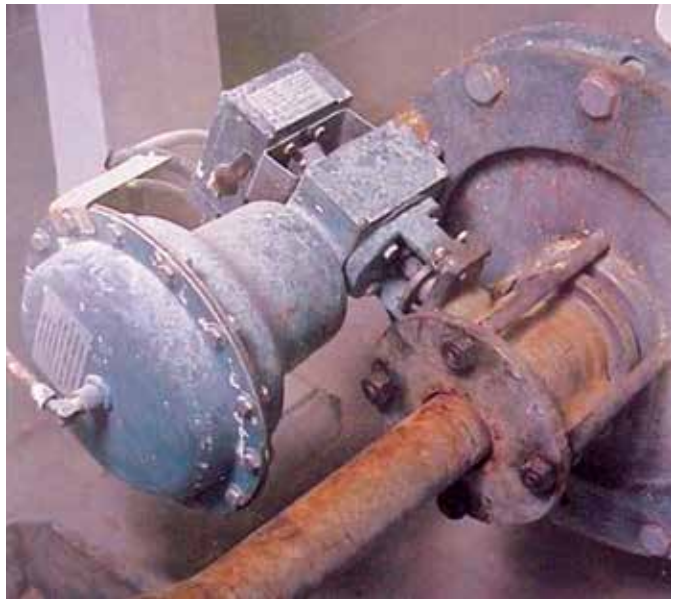

DeZURIK RCV Rotary Control Valve in abrasive kaolin clay slurry application.



DeZURIK's versatile VPB V-Port Ball Valves are designed for highly accurate control of paper stock, in addition to other clean, dirty or corrosive liquids and gases.





DeZURIK's 3-Way Tapered Plug Valves are designed for throttling and diverting applications in refiner stock control applications.

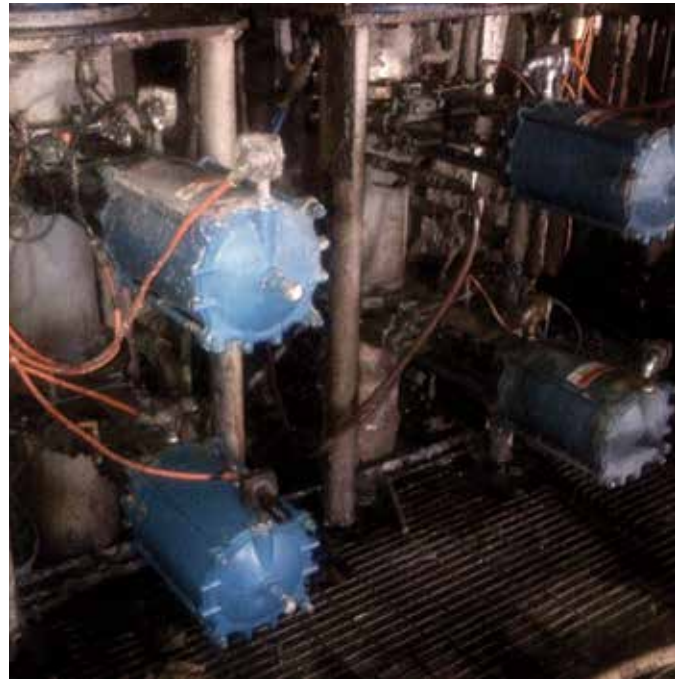

DeZURIK KGC Knife Gate Valves are proven performers in Recycle Paper High Density Cyclone Cleaners. The KGC-MC valve is ideally suited for recycle applications that require shearing of media containing heavy trash, solids, nails, wire, staples, plastic or glass.

Local Service and Support

DeZURIK Service Centers and local representatives maintain local inventory for quick delivery. Service Center and field service capabilities include automation, repair, reconditioning, emergency service, on-site scheduled maintenance and accuracy testing.



Accurate Control Valves with 100% Stainless Steel Package

DeZURIK V-Port Ball Valves and Rotary Control Valve can deliver unmatched corrosion protection with a complete stainless-steel package that includes valve, actuator, mounting bracketry and flexible stainless hose and fittings. The DeZURIK Control Valve Package combines superior control accuracy with industry-leading materials and durability.



Leading Basis Weight Control Valve

DeZURIK's Precision Electric Control Valve is recognized industry wide as the most accurate and reliable basis weight control valve available. This high-resolution control valve is designed specifically for critical paper stock control, and is used for basis weight and head box level control applications. It provides unmatched control accuracy, positioning and repeatability.

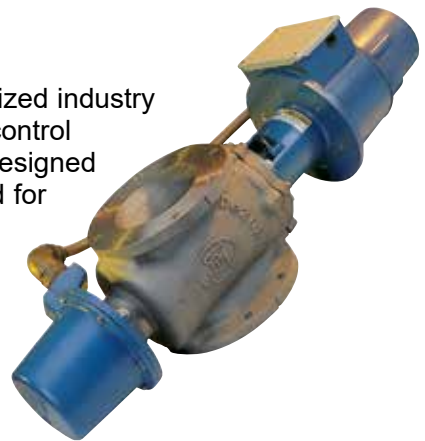

Premier & Proven Knife Gate Valves

As a leading knife gate valve manufacturer for over 50 years, DeZURIK sets the standard for cast stainless steel knife gate valves. Widely used in pulping and stock prep operations throughout the mill, DeZURIK Knife Gate designs include the KGC-ES Extended Service Knife Gate Valves, KGC-MC Metal Cutting Knife Gate Valves, KGC-BD Bi-Directional Knife Gate Valves and KGC-MD Maximum Duty Knife Gate Valves. DeZURIK KGC Knife Gate Valves all include stainless steel cast construction, the exclusive premium packing system and common actuator mounting.

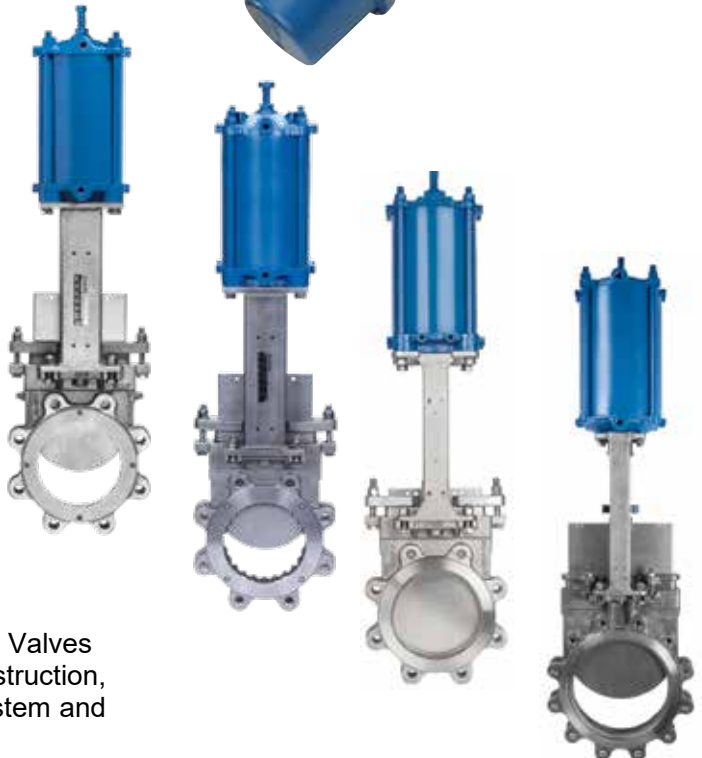

Specialty Knife Gate Valves

A wide variety of specialty valves are available including custom fabricated Hilton Bonneted Knife Gate Valves; DeZURIK Cast Stainless Steel O-Port valve for handling high density pulp stock, recycle trash, pellets and wood chips; and Level Sensor Isolation Valves that allow convenient removal of the sensor from the stock chest.



Eccentric Plug Valves & 3-Way/4-Way Plug Valves







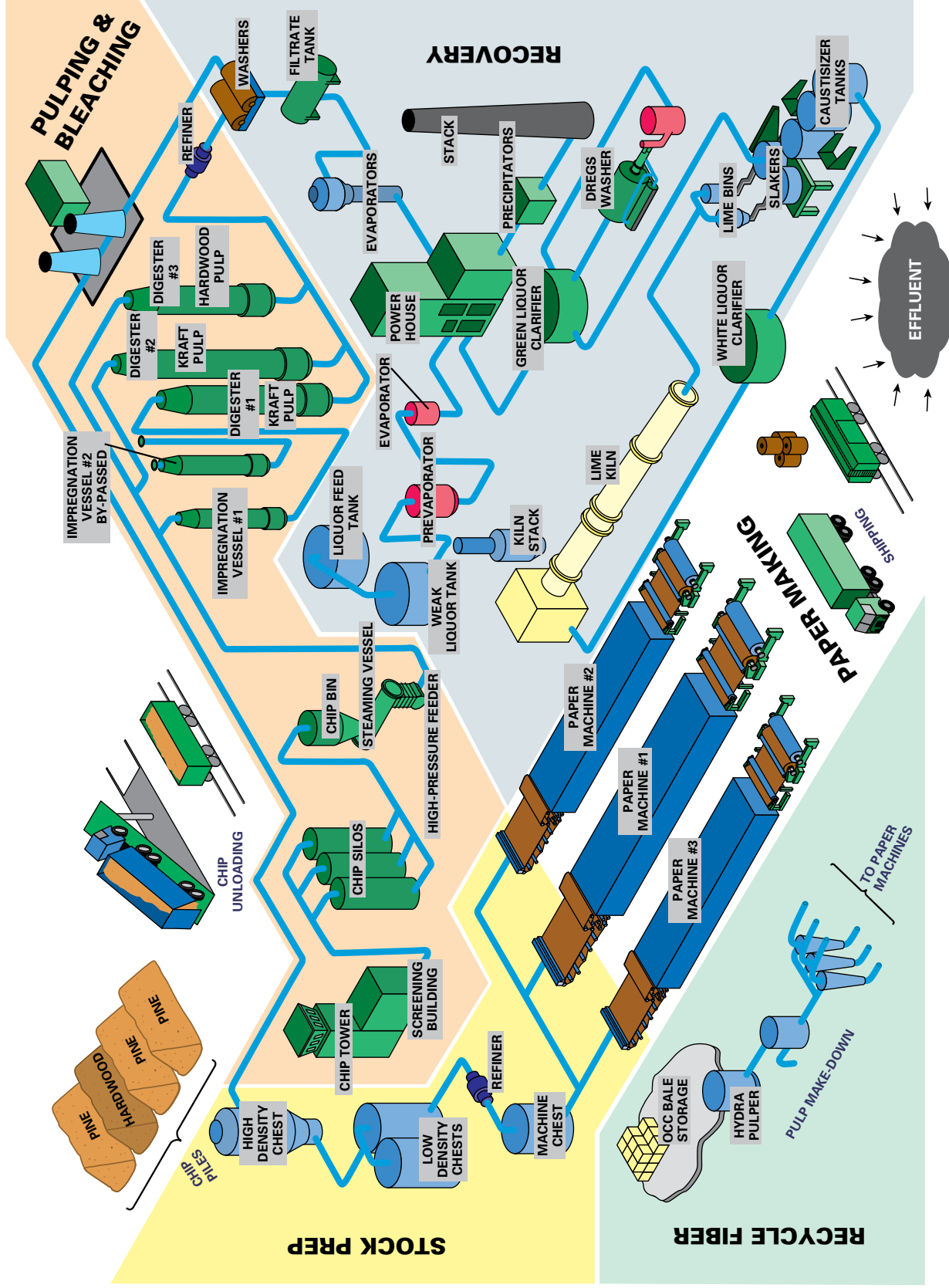











In thousands of installations worldwide, DeZURIK Eccentric Plug Valves have a proven record of long-term reliability. A wide variety of value-added design features and lowest total cost of ownership have made it the preferred choice for isolation, throttling and control applications. DeZURIK 3-Way and 4-Way Plug valves are ideal for throttling and diverting. All DeZURIK Plug Valves offer outstanding service in clean, dirty and corrosive liquids, gases and slurries.



DeZURIK Product Applications in the Paper Industry





Legend

	Lever On/Off		Knife Gate Valve - Blocking Valves		Rotary Control Valve - Steam Control - Abrasive Media Control - Dilution Water Control
	Handwheel On/Off		Maximum Duty Knife Gate Valve - Sand Separator		Level Sensor Isolation Valve - Isolation Control
	Control		Metal Cutting Knife Gate Valve - HD Cleaner - Pulper Rejects		O-Port Gate Valve - High Consistency Paperstock - Trash Handling
	Cylinder On/Off		V-Port Ball Valve - Paperstock Control Valves - Dilution Water Control		Resilient Seated Butterfly Valve - Vacuum Service Air and Water
	3-Way Handwheel On/Off		High Performance Butterfly Valve - Vacuum and Air Control - Water and Condensate - Stock Shut-Off		
	3-Way Control		Eccentric Plug Valve - Dilution Water Control - Clarifier and Thickener Effluent		
			3-Way Plug Valve - Refiner Stock Control		
			Precision Electric Valve - Paperstock Feed to the Paper Machine		

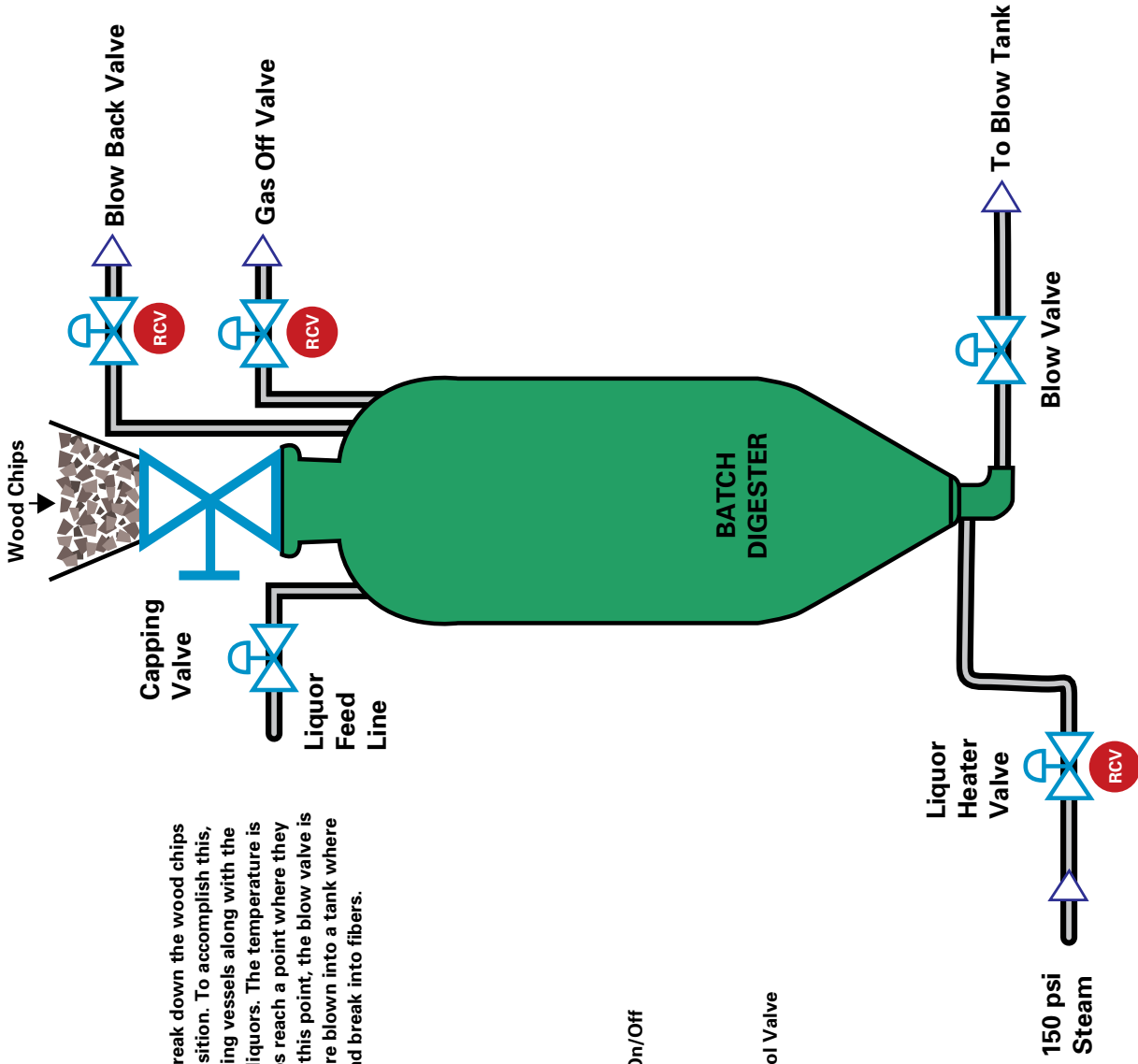
Batch Digesters / Direct Heating





Digesters are used to break down the wood chips and soften their composition. To accomplish this, steam is added to cooking vessels along with the chips, white and black liquors. The temperature is increased until the chips reach a point where they start to breakdown. At this point, the blow valve is opened and the chips are blown into a tank where they impact the wall and break into fibers.

-  Handwheel On/Off
-  Control
-  Rotary Control Valve

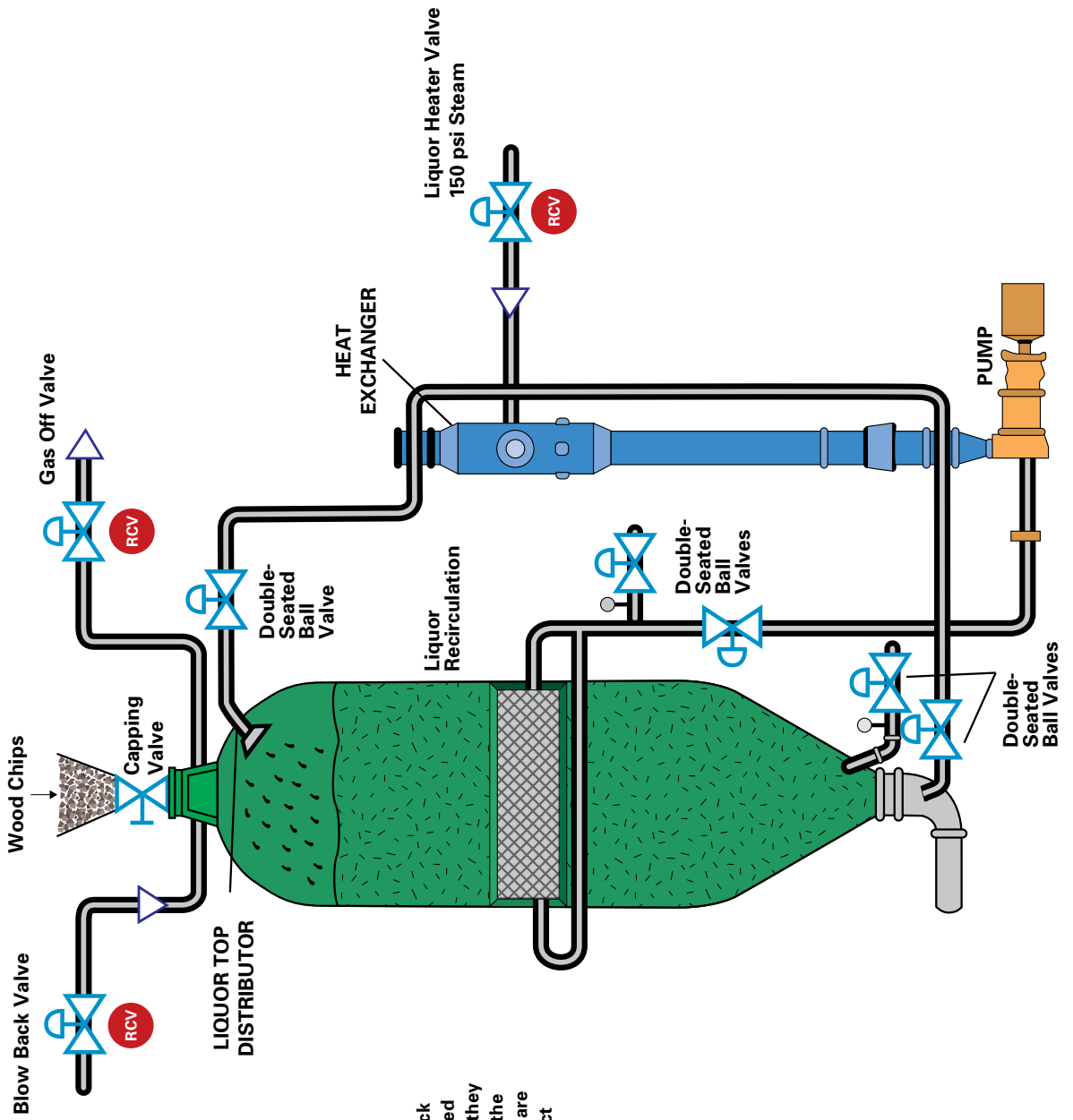
Batch Digester / Indirect Heating



Digesters are used to break down the wood chips and soften their composition. To accomplish this, steam is added to cooking vessels along with the chips, white and black liquors. The temperature is increased until the chips reach a point where they start to break down. At this point, the blow valve is opened and the chips are blown into a tank where they impact the wall and break into fibers.

-  Handwheel On/Off
-  Control
-  RCV Rotary Control Valve

Kamyr Continuous Digester

For Kamyr digester valve applications contact DeZURIK Application Engineering.

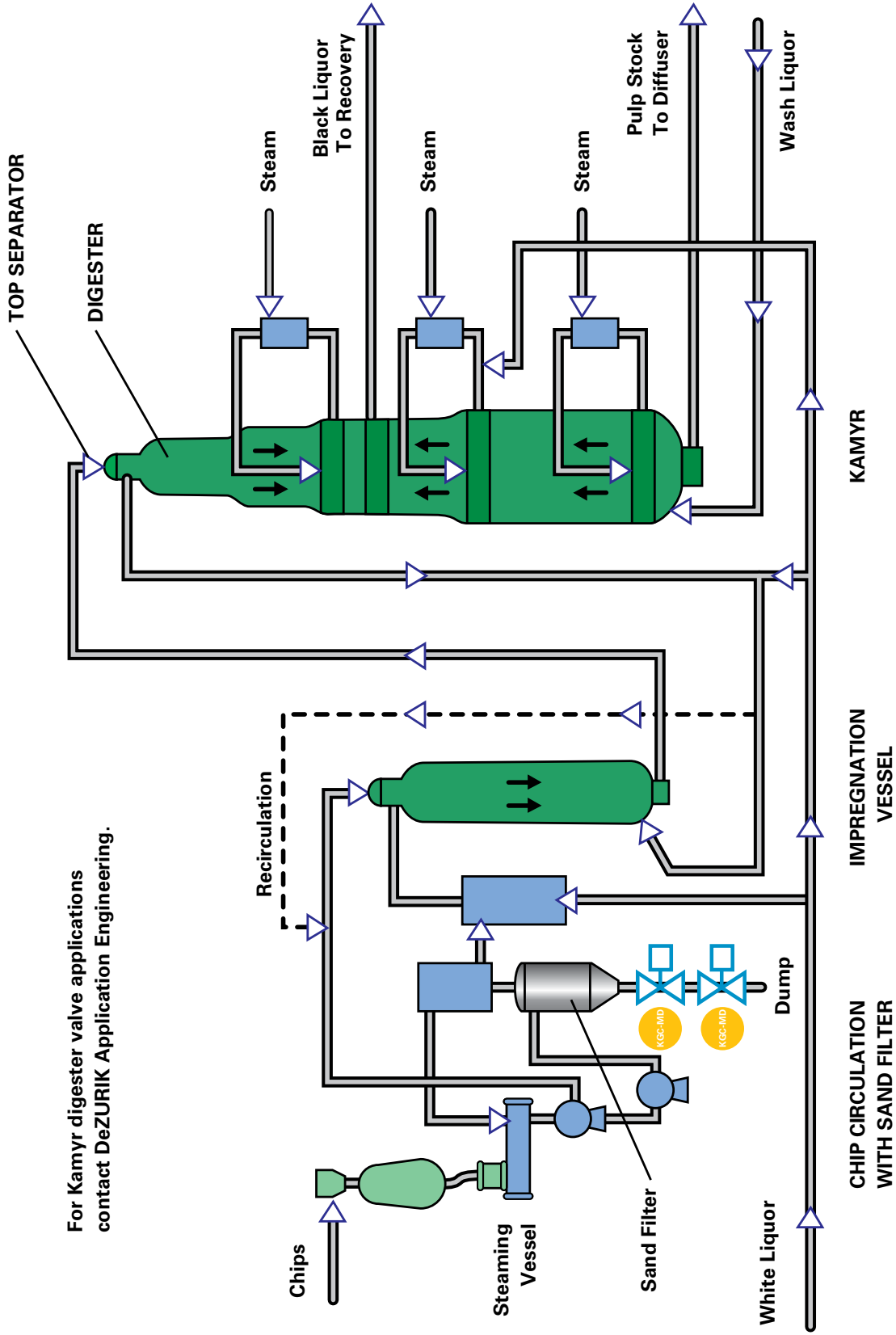

KGC-MD Maximum Duty Knife Gate Valve

Turpentine Recovery System

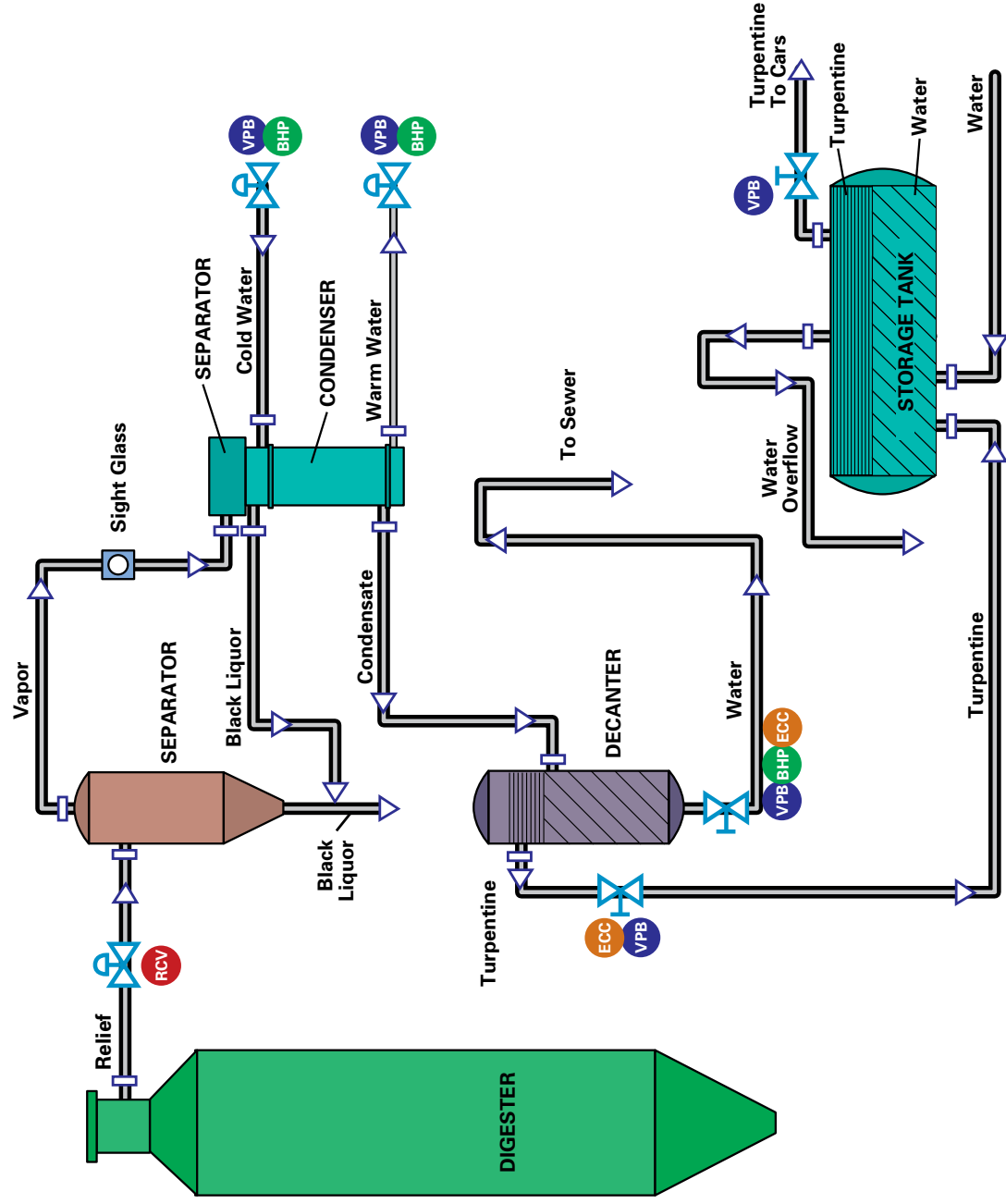

-  Rotary Control Valve
-  V-Port Ball Valve
-  High Performance Butterfly Valve
-  Eccentric Plug Valve
-  Handwheel On/Off
-  Control

Thermomechanical Pulping Process (TMP)

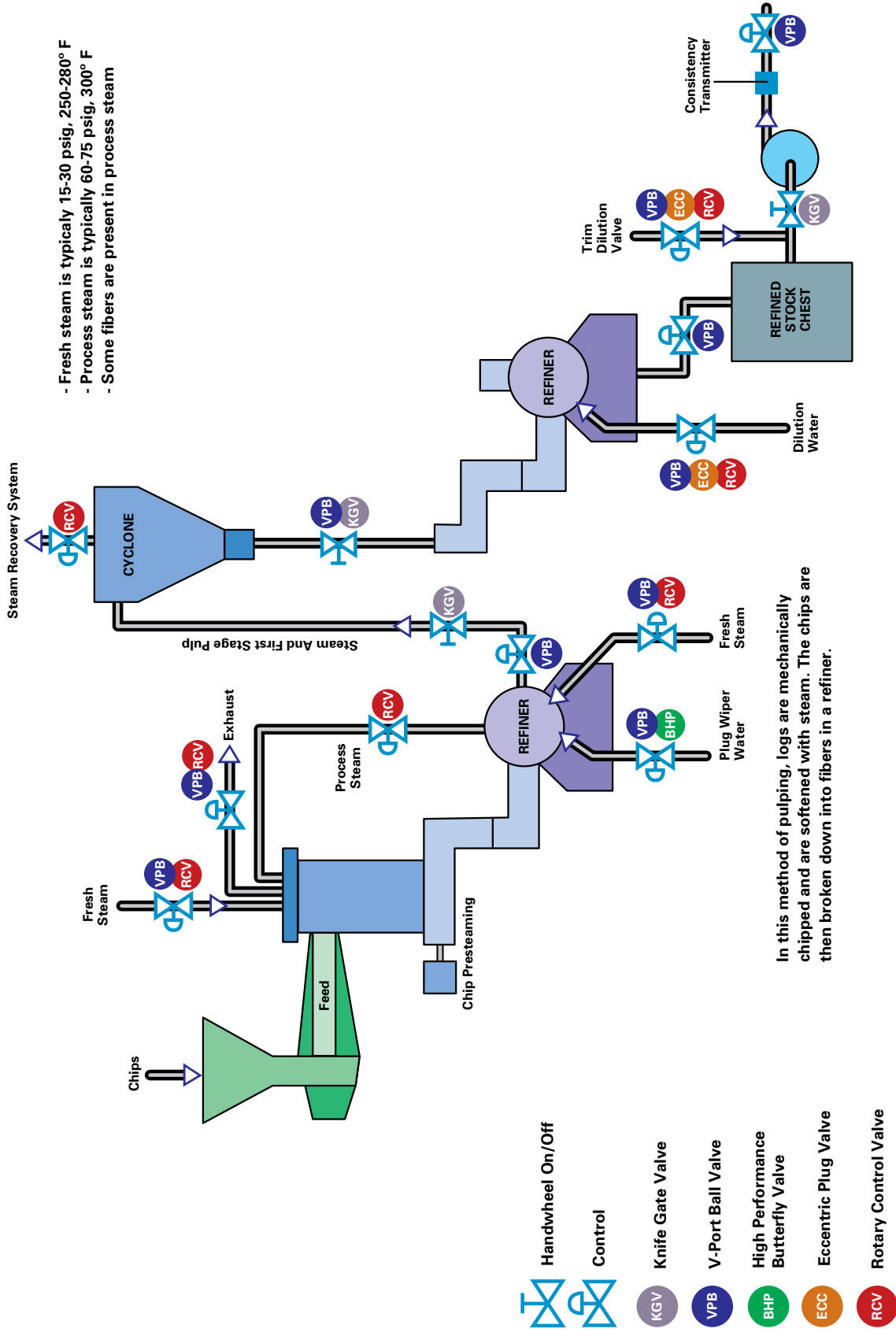

- Fresh steam is typically 15-30 psig, 250-280° F
- Process steam is typically 60-75 psig, 300° F
- Some fibers are present in process steam

In this method of pulping, logs are mechanically chipped and are softened with steam. The chips are then broken down into fibers in a refiner.

- Handwheel On/Off Control
- KGV Knife Gate Valve
- VPB V-Port Ball Valve
- BHP High Performance Butterfly Valve
- ECC Eccentric Plug Valve
- RCV Rotary Control Valve

Chemical - Thermomechanical Pulping (CTMP)

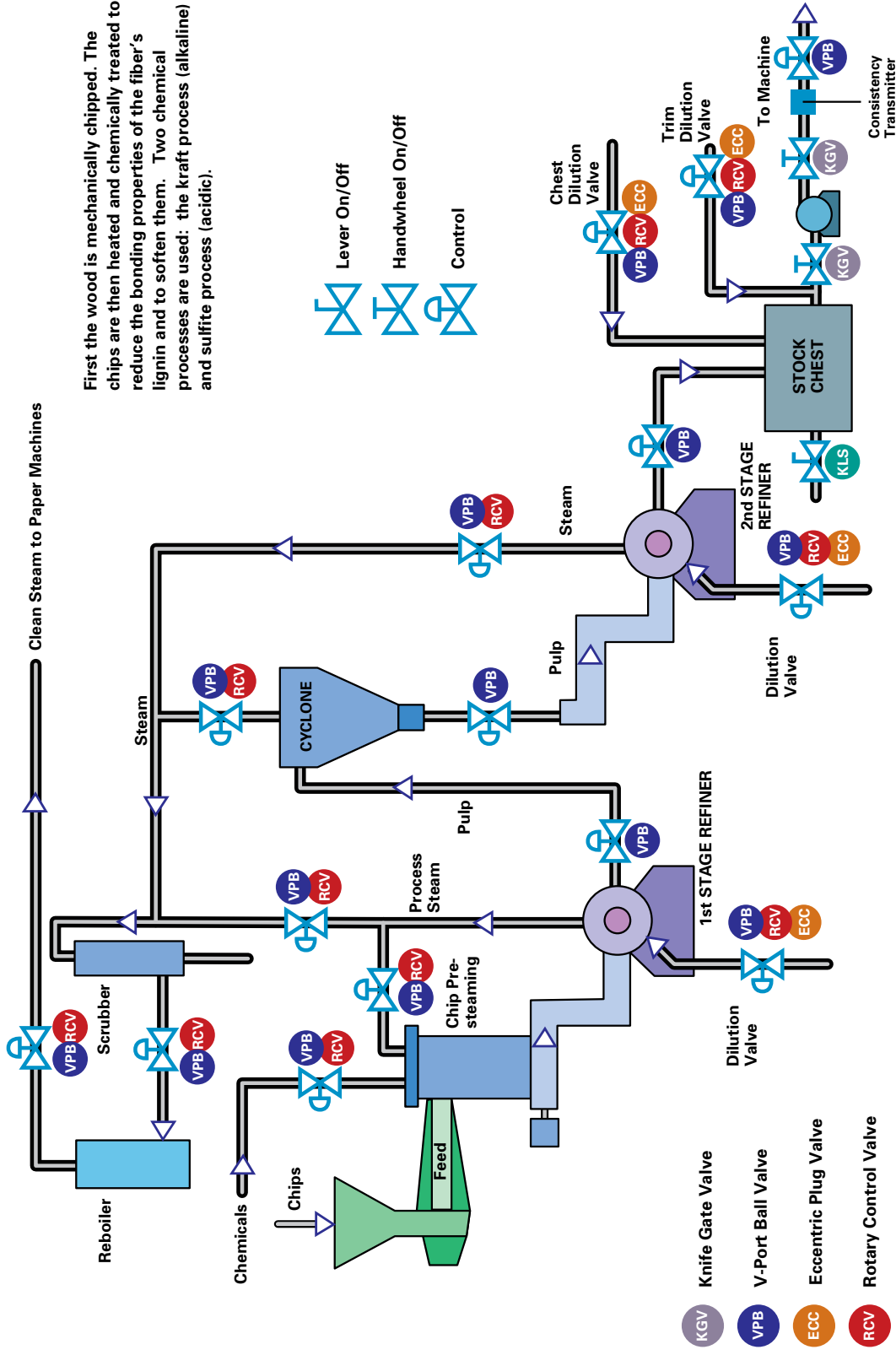

First the wood is mechanically chipped. The chips are then heated and chemically treated to reduce the bonding properties of the fiber's lignin and to soften them. Two chemical processes are used: the kraft process (alkaline) and sulfite process (acidic).

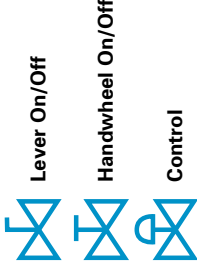

- KGV Knife Gate Valve
- VPB V-Port Ball Valve
- ECC Eccentric Plug Valve
- RCV Rotary Control Valve
- KLS Level Sensor Isolation Valve

Brown Stock Washing

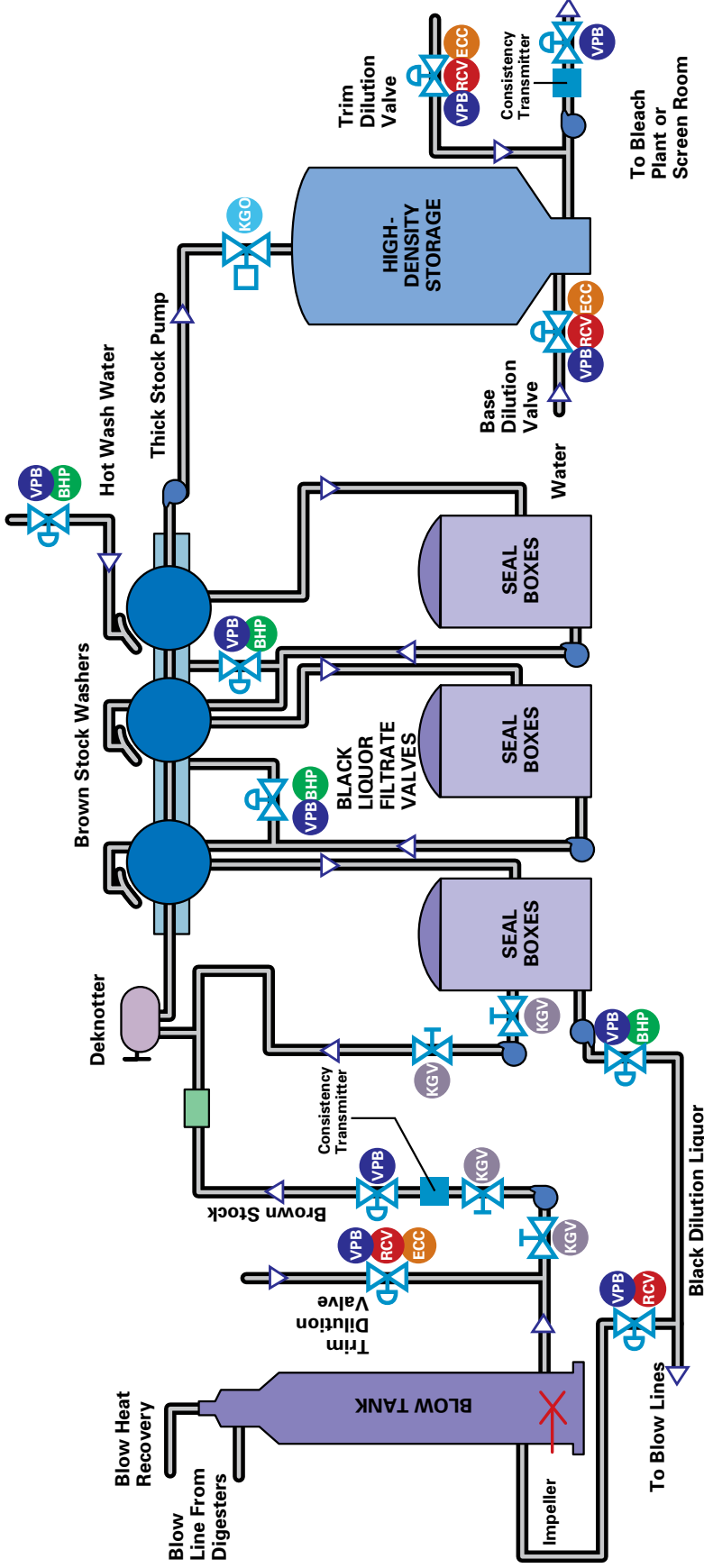

After the stock is injected at high velocity into the blow tank and the chips are broken down into fibers, a deknotted separates the chips and knots. The knots are then discarded or sent back to the digesters for further processing. The pulp (cooked fibers) is washed to remove residual liquors that will contaminate the process and also to recover the maximum amount of chemicals. The spent chemicals that are recovered go to seal boxes and then are reclaimed for later use. The washed pulp is pumped into high-density storage tanks and from there it goes to the bleach plant or to the screen room.

-  Handwheel On/Off
-  Control
-  Cylinder On/Off
-  Knife Gate Valve
-  V-Port Ball Valve
-  High Performance Butterfly Valve
-  Eccentric Plug Valve
-  Rotary Control Valve
-  O-Port Gate Valve
-  BHP
-  ECC
-  RCV
-  KGO

Recovery Boiler

The highly concentrated black liquor is sprayed into the recovery boiler and the heat generated from this is used for making steam to run other parts of the mill. The inorganic smelt that forms as the black liquor is burned flows to a smelt desolving tank where it is cooled and desolved in water forming unclarified green liquor.

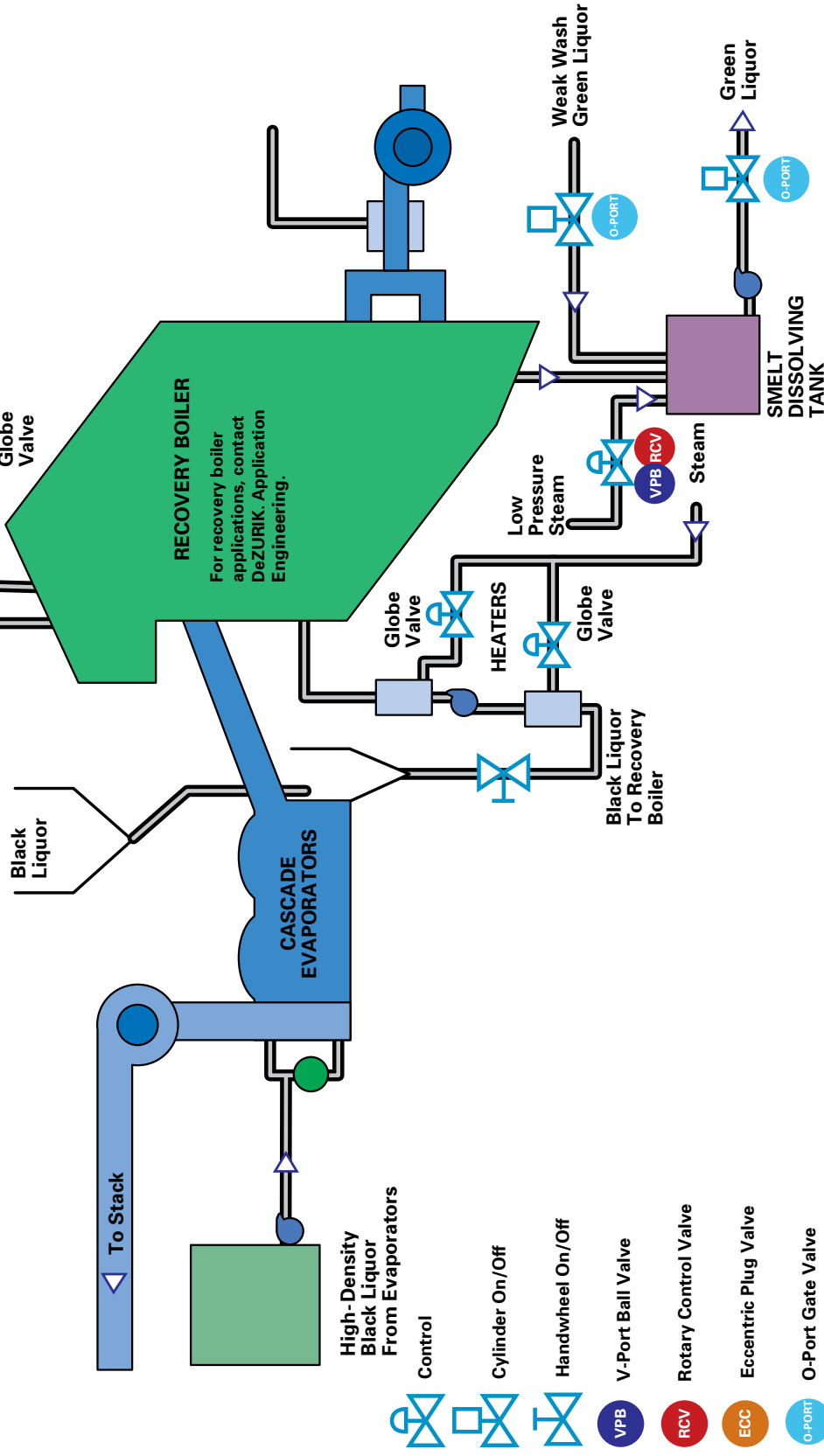

Bleaching - Chlorine Vaporization

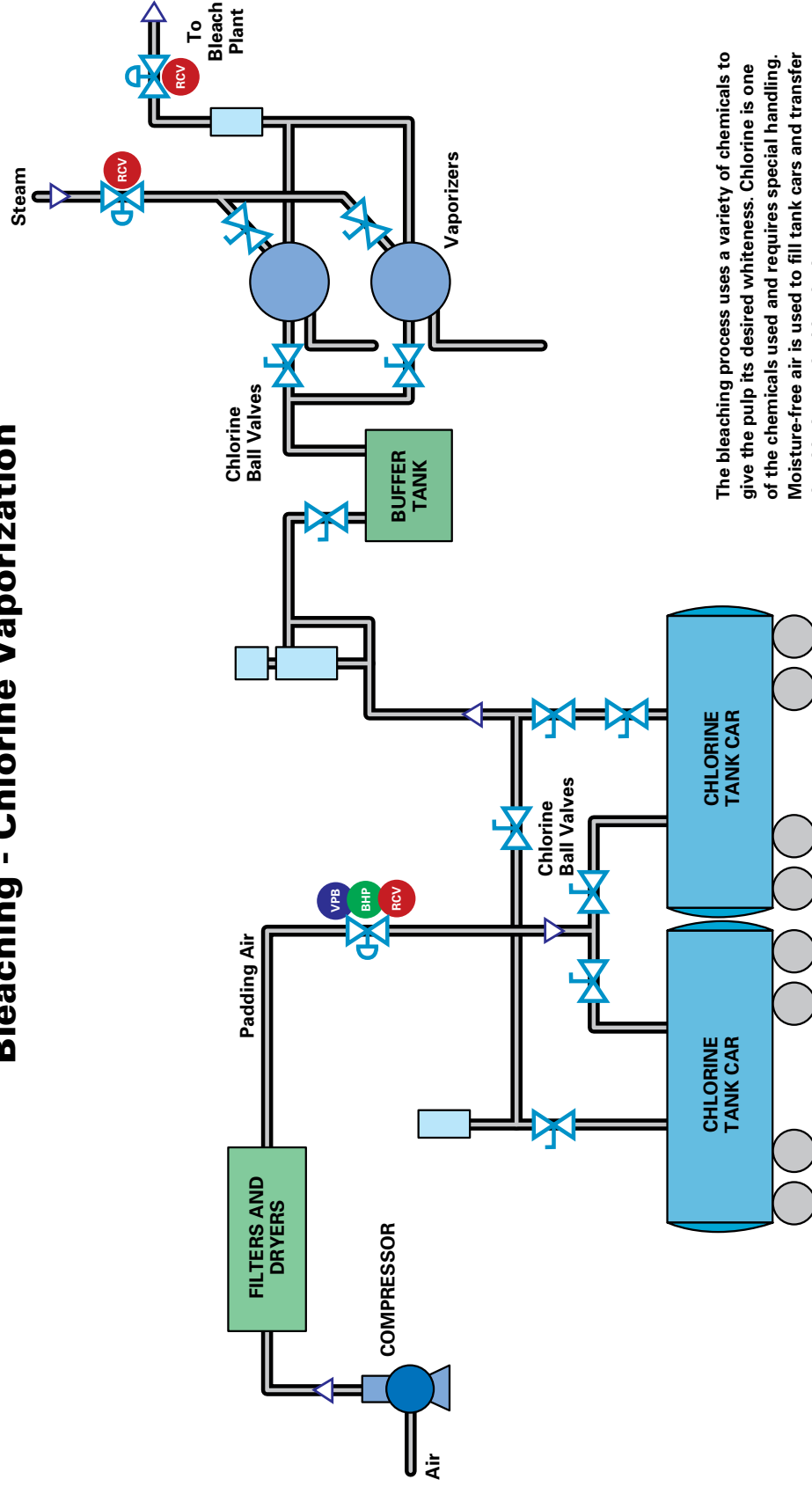

The bleaching process uses a variety of chemicals to give the pulp its desired whiteness. Chlorine is one of the chemicals used and requires special handling. Moisture-free air is used to fill tank cars and transfer the chlorine to the bleach plant.

-  Lever On/Off Control
-  V-Port Ball Valve
-  High Performance Butterfly Valve
-  Rotary Control Valve

Bleach Plant

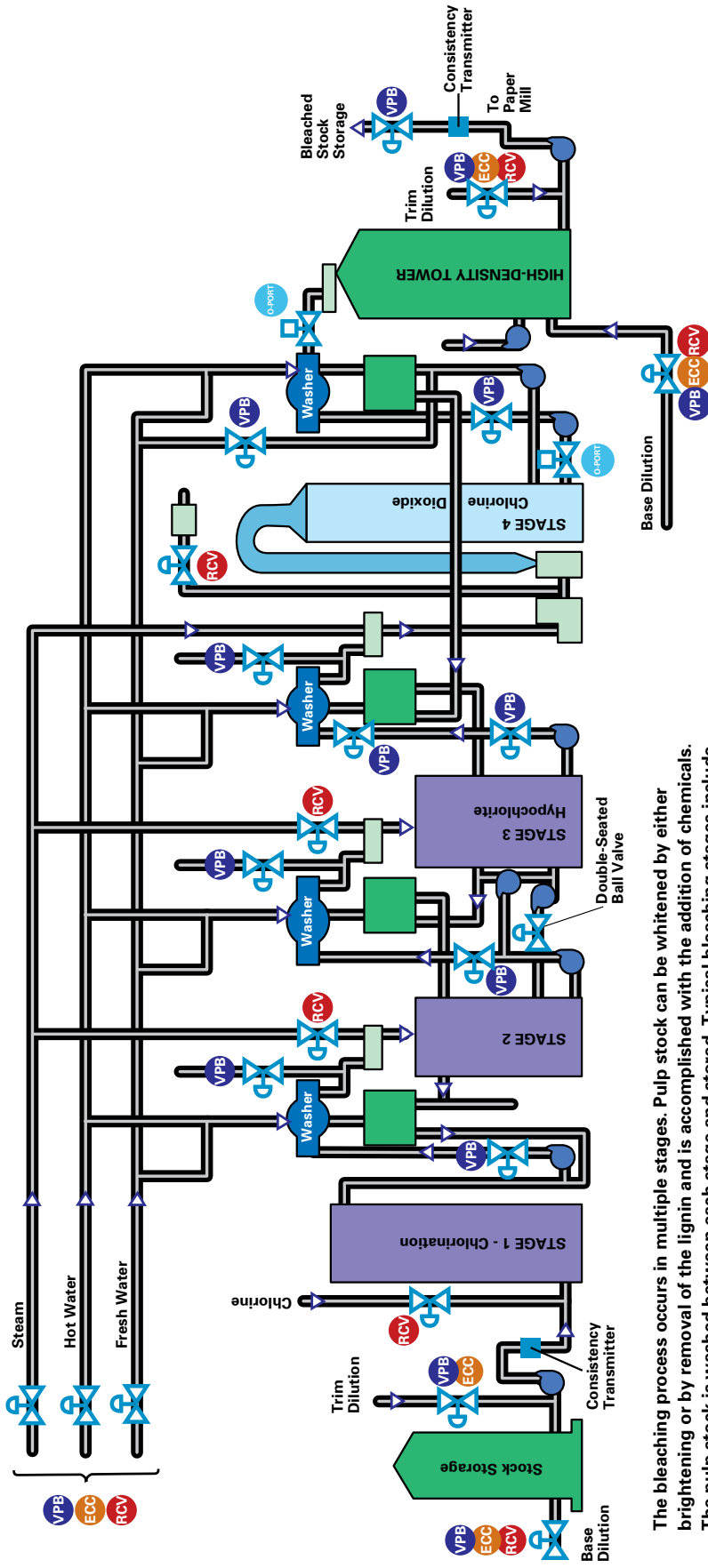

The bleaching process occurs in multiple stages. Pulp stock can be whitened by either brightening or by removal of the lignin and is accomplished with the addition of chemicals. The pulp stock is washed between each stage and stored. Typical bleaching stages include chlorination, alkaline extraction, oxygen, hypochlorite, chlorine dioxide, peroxide and ozone.

- Control
- Cylinder On/Off
- Knife Gate Valve
- Rotary Control Valve
- V-Port Ball Valve
- O-Port Gate Valve
- Eccentric Plug Valve

Stock Preparation and Blending Overview

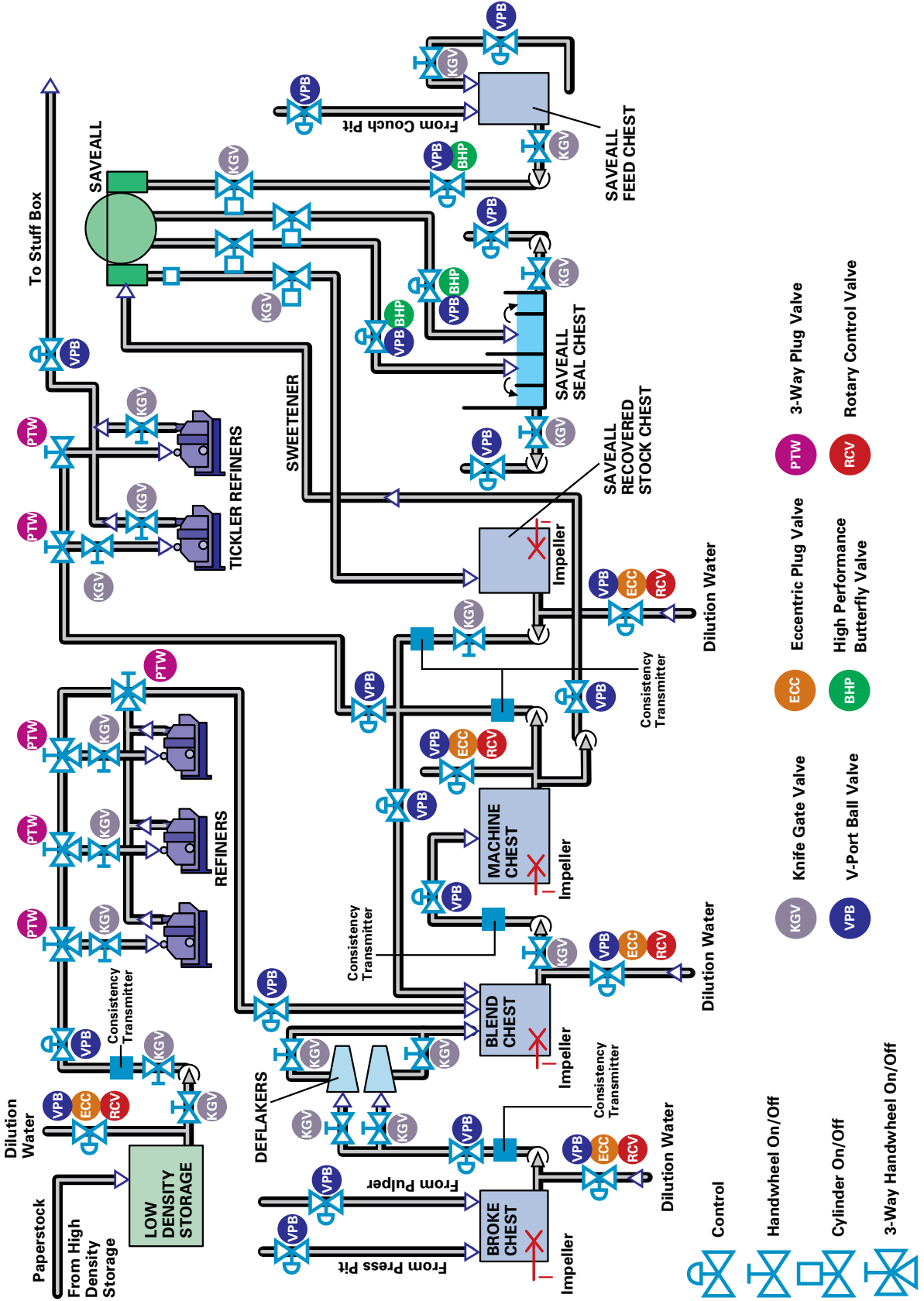

Cleaners

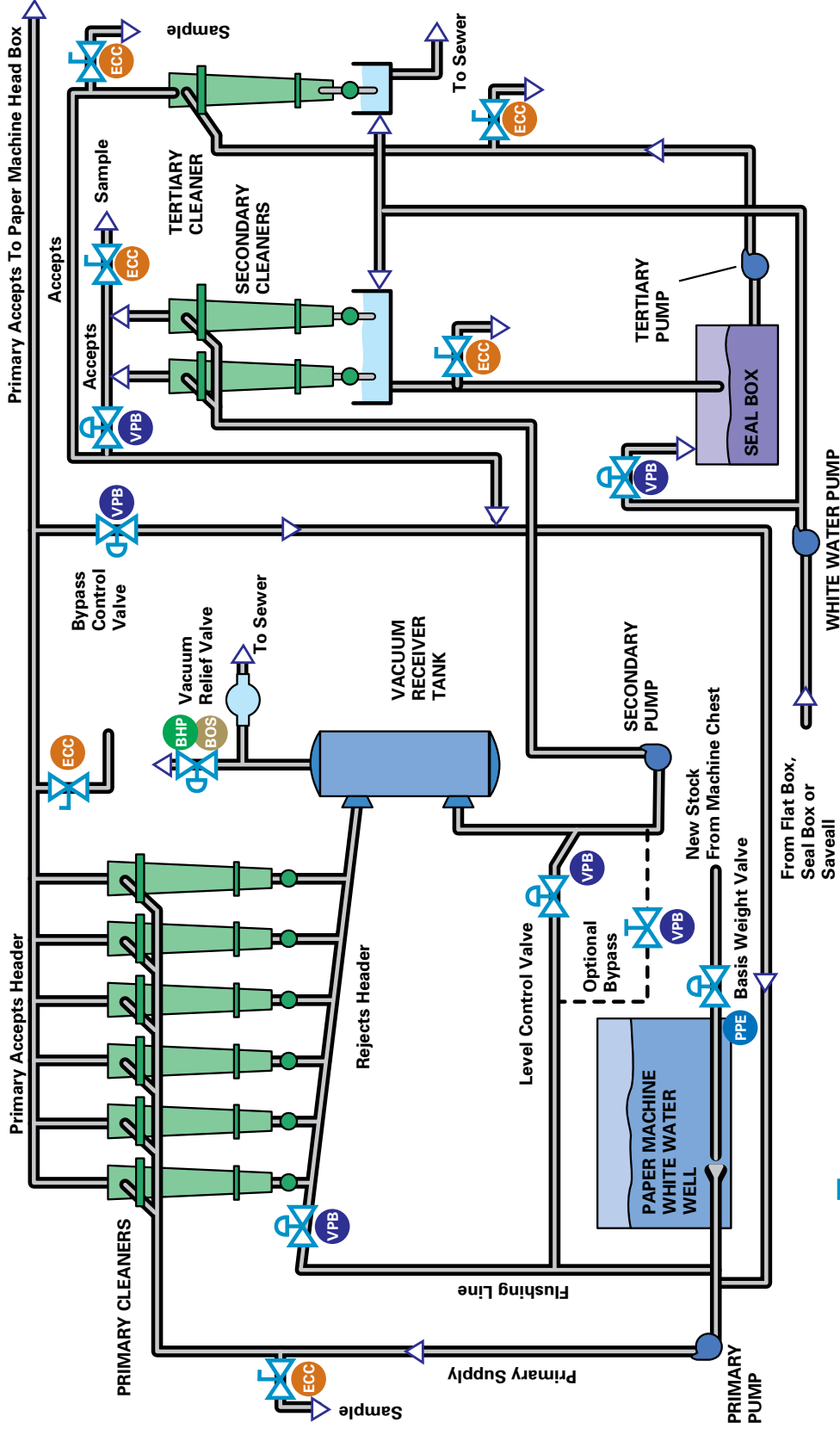

Primary, secondary and tertiary stage cleaners are used in stock preparation to eliminate all unwanted materials.

- Control
- Lever On/Off
- Precision Electric Valve
- Handwheel On/Off
- V-Port Ball Valve
- Eccentric Plug Valve
- Resilient Seated Butterfly Valve
- High Performance Butterfly Valve



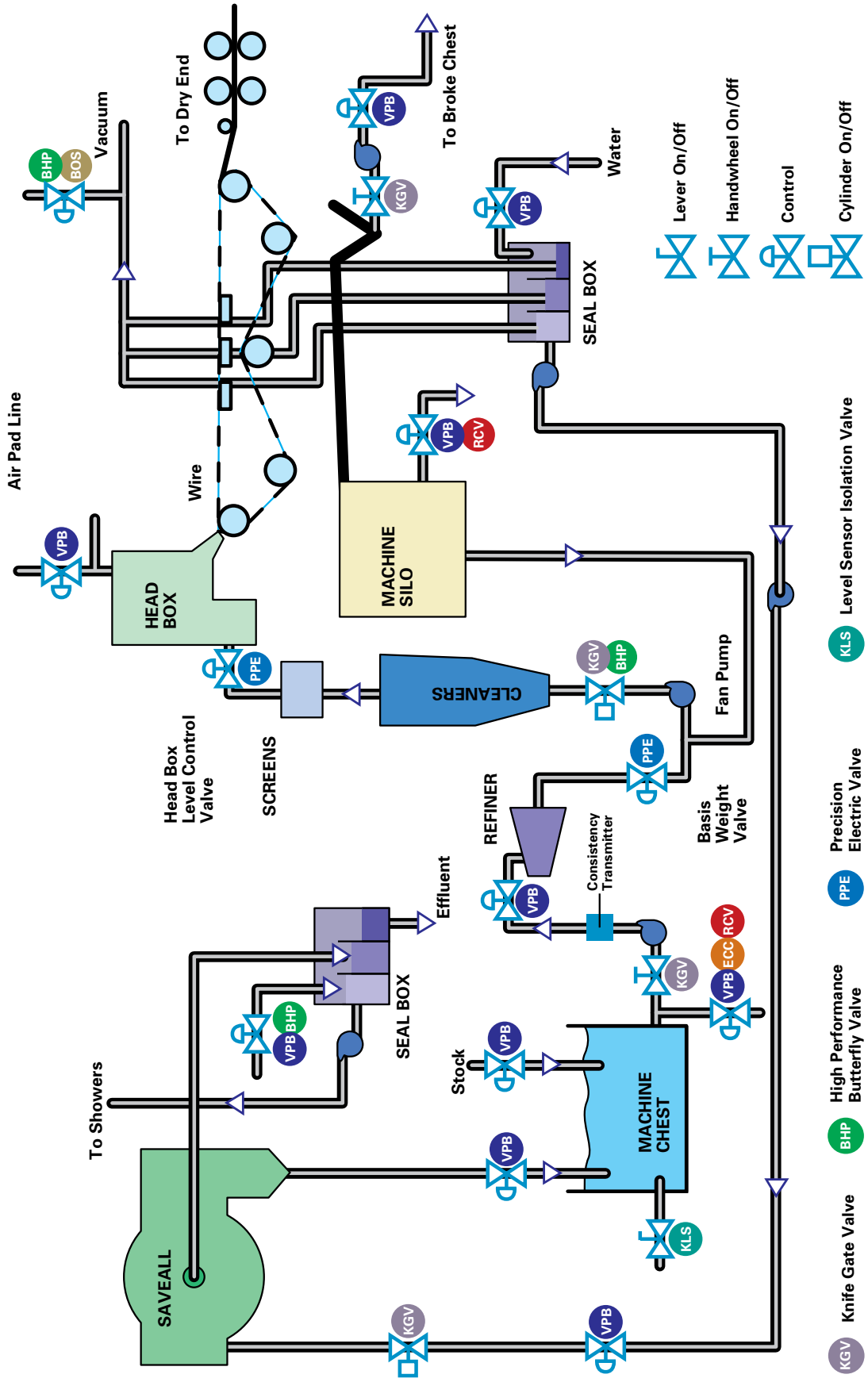





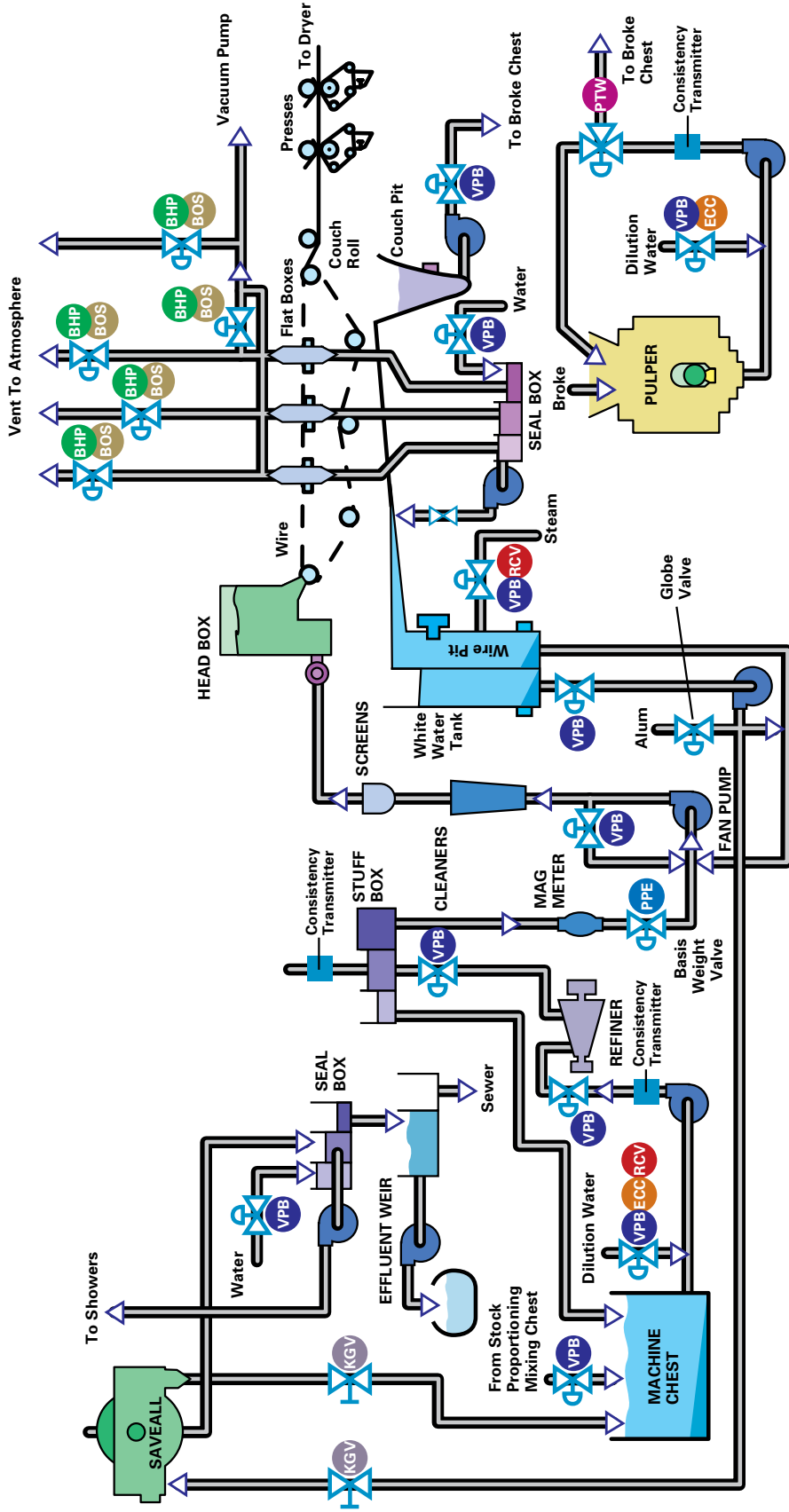

Paper Machine Wet End



- Knife Gate Valve
- V-Port Ball Valve
- High Performance Butterfly Valve
- Resilient Seated Butterfly Valve
- Precision Electric Valve
- Rotary Control Valve
- Eccentric Plug Valve
- Level Sensor Isolation Valve
- Lever On/Off
- Handwheel On/Off
- Control
- Cylinder On/Off







Fourdrinier Wet End

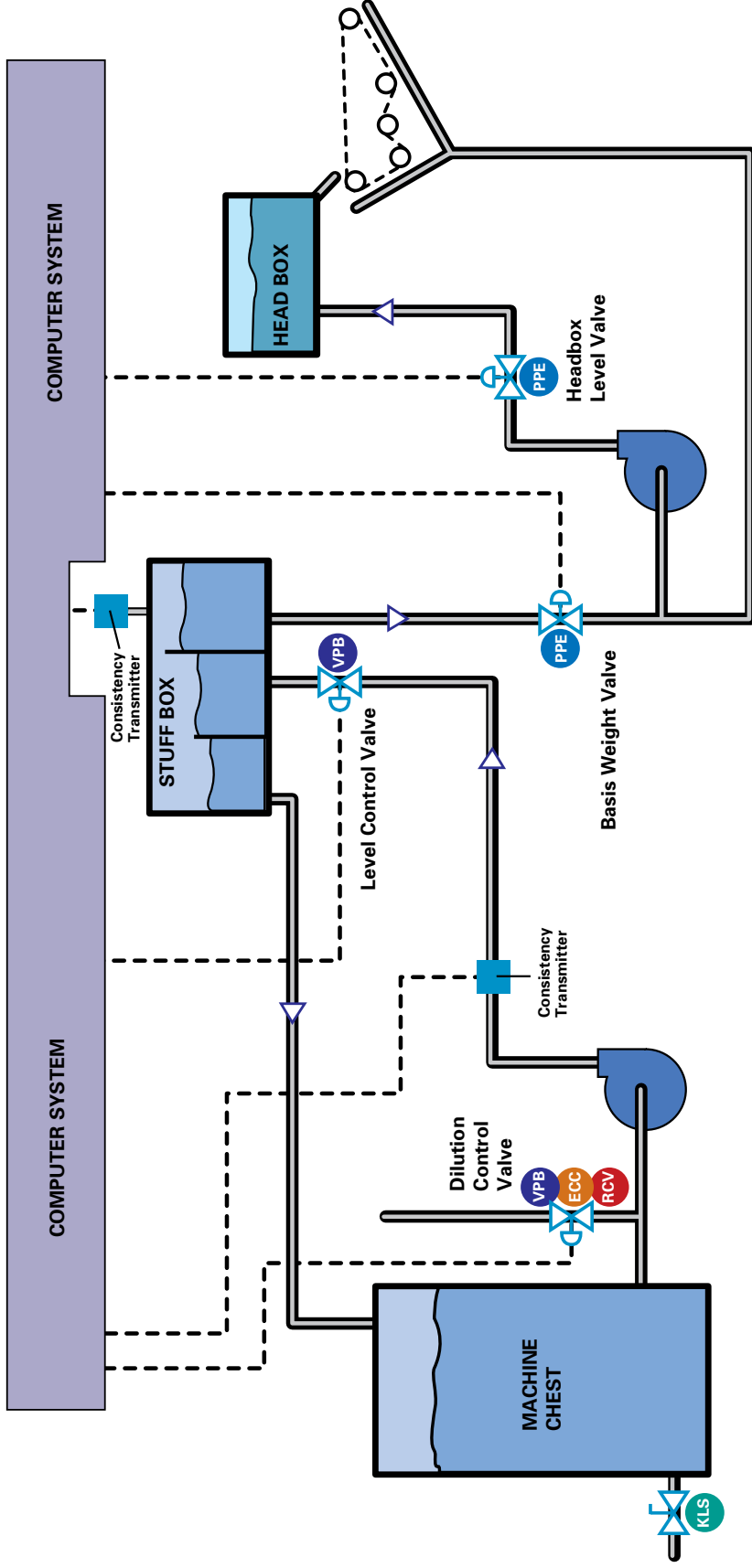

-  Control
-  Handwheel On/Off
-  3-Way Control
-  KGV Knife Gate Valve
-  BHP High Performance Butterfly Valve
-  RCV Rotary Control Valve
-  VPB V-Port Ball Valve
-  ECC Eccentric Plug Valve
-  PPE Precision Electric Valve
-  PTW 3-Way Plug Valve
-  BOS Resilient Seated Butterfly Valve

Basis Weight Control



-  Lever On/Off
 -  Control
 -  V-Port Ball Valve
 -  Eccentric Plug Valve
 -  Precision Electric Valve
 -  Rotary Control Valve
 -  Level Sensor Isolation Valve
- The basis weight valve is used to control the amount of stock to the head box and is positioned by the mill's Distributive Control System (DCS) or the gauging system which measures the density and thickness of the finished sheet of paper.
- Basis weight control requires constant pressure and consistency to the valve. Alternatively, this loop may be controlled by a Variable Frequency Drive (VFD) that would not require a valve.

Paper Machine Dryer Section

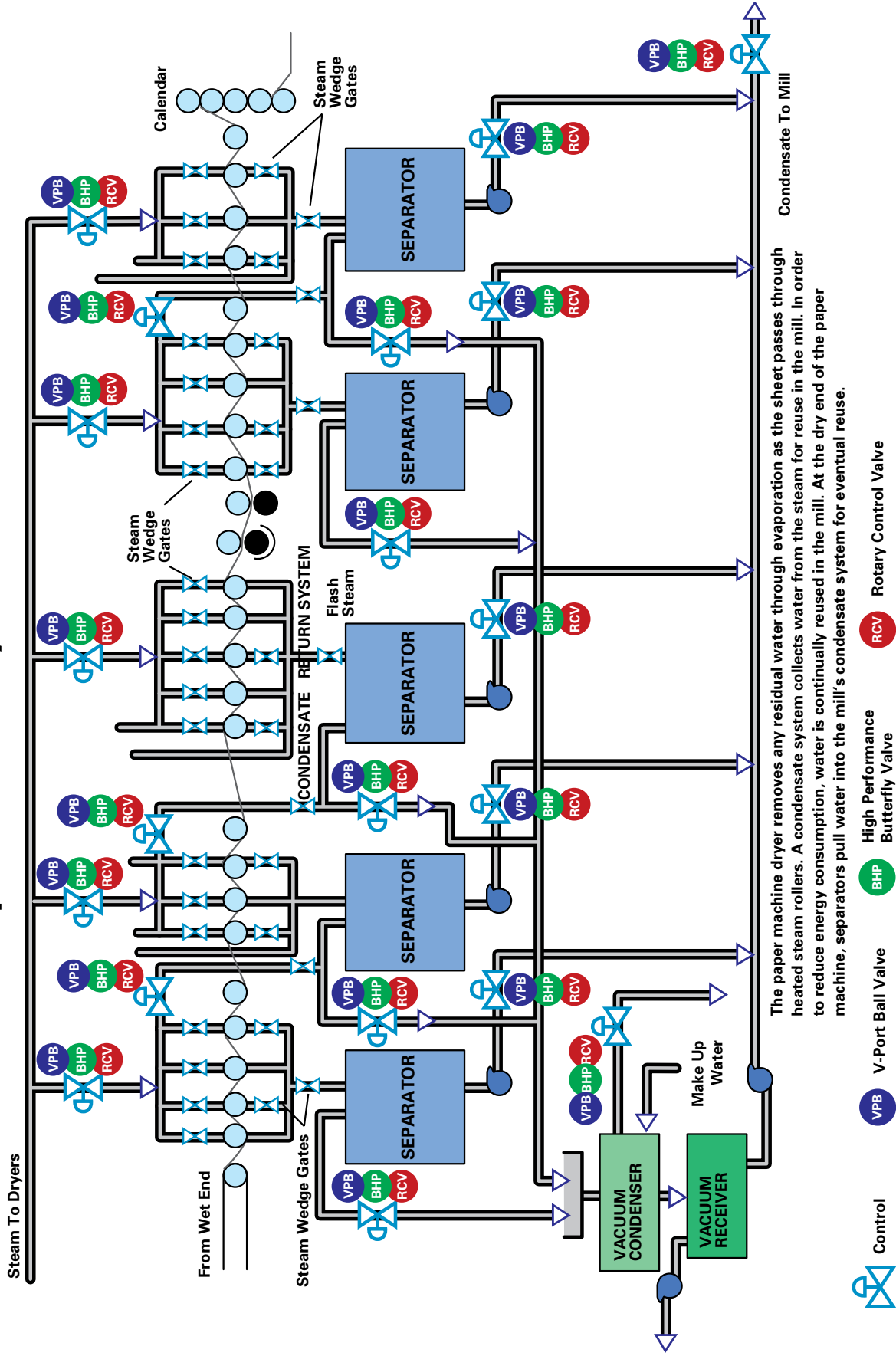

The paper machine dryer removes any residual water through evaporation as the sheet passes through heated steam rollers. A condensate system collects water from the steam for reuse in the mill. In order to reduce energy consumption, water is continually reused in the mill. At the dry end of the paper machine, separators pull water into the mill's condensate system for eventual reuse.

Facilities



DeZURIK Corporate Headquarters and Manufacturing Facility, Sartell, MN USA
Established in 1928, 420,000 sq. ft.



DeZURIK Cambridge, Ontario, Canada
Established in 1961, 50,000 sq. ft.



Rapid Fulfillment Center, Houston, TX, USA
Established in 2018, 43,000 sq. ft.



DeZURIK, Redmond, WA, USA
Established in 1952, 25,000 sq. ft.

Sales and Service

For information about our worldwide locations, approvals, certifications and local representative:

Web Site: DeZURIK.com E-Mail: info@DeZURIK.com



250 Riverside Ave. N. Sartell, Minnesota 56377 • Phone: 320-259-2000 • Fax: 320-259-2227

DeZURIK, Inc. reserves the right to incorporate our latest design and material changes without notice or obligation. Design features, materials of construction and dimensional data, as described in this bulletin, are provided for your information only and should not be relied upon unless confirmed in writing by DeZURIK, Inc. Certified drawings are available upon request.